

# Danmity



# Vanilla

Vanilla

Franco Bertozzini design



*Vanilla*



*Vanilla*



*Vanilla*



*Vanilla*



*Vanilla*





*Vanilla*



*Dolce Vita*  
Franco Bertozzini design  
*Dolce Vita*



*Dolce Vita*



*Dolce Vita*



*Dolce Vita*



*Dolce Vita*



*Diamond*  
Liviano Battistoni design



*Diamond*





*Diamond*



*Diamond*



*Diamond*



*Diamond*



*Diamond*



*Diamond*



*Elizabeth*  
Franco Bertozzini design

*Elizabeth*



*Elizabeth*





*Elizabeth*



*Elizabeth*



*Helen*  
Liviano Battistoni design



*Helen*



*Helen*



*Helen*



*Joy*  
Franco Bertozzini design



*Joy*





*Dada*  
Liviano Battistoni design  
*Dada*





*Dada*

*Juliet*  
Franco Bertozzini design



*Juliet*



*Juliet*



# Matisse

Liviano Battistoni design



*Matisse*



*Matisse*





*Sezione Tecnica*  
Technical section

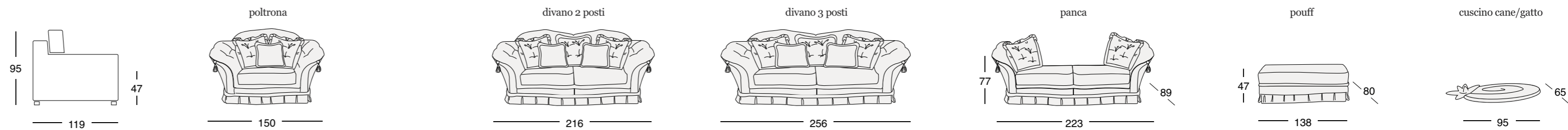

Composizioni delle foto a catalogo / Compositions of the photos in the catalog

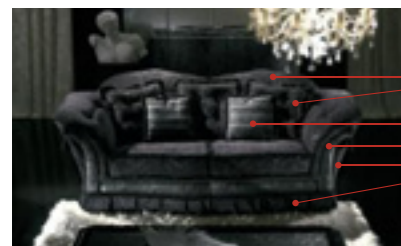

Tessuto R 96  
Tessuto R 97  
Tessuto R 109  
Tessuto R 99

pag. 4/5

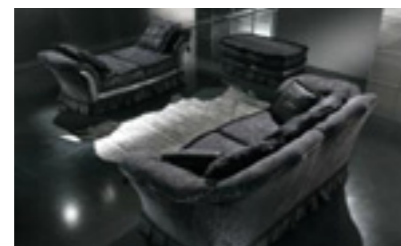

pag. 6/7



Tessuto R 01  
Tessuto R 03  
Tessuto R 108  
Tessuto R 03

Tessuto R 03

pag. 12/13



pag. 8/9

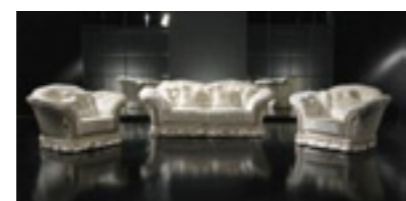

pag. 10/11



pag. 14/15

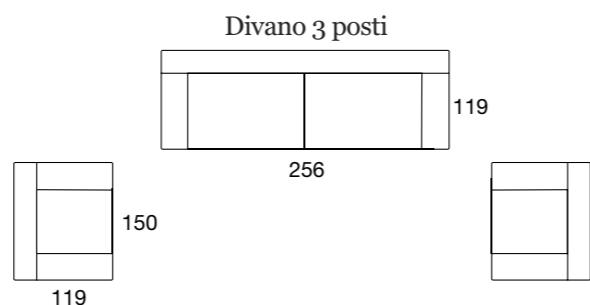
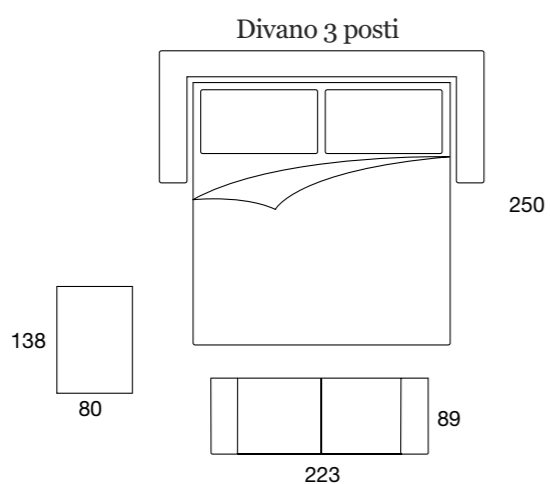
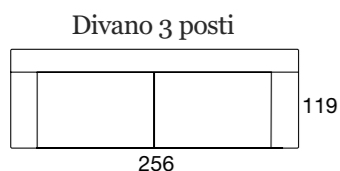

- Struttura in legno stagionato, con tamponamenti in multistrato di legno facilmente riciclabile e biodegradabile.
- Molleggio di seduta con nastro elastico da mm. 80 teso meccanicamente.
- Cuscini di seduta e spalliere in poliuretano espanso varie densità indeformabile e ovatta di poliestere.
- Cuscini di schienale in fiocco di fibra di poliestere.
- Piedini in legno finitura wengè.

- Structure of seasoned wood, with plywood easily recyclable, biodegradable.
- Sitting springs furnished with an elastic band of 80mm. mechanically stretched.
- Sitting cushions and back of polyurethane, that doesn't change their shape, in different thickness and polyester wadding.
- Back cushions of polyester padding.
- Dark- brown wood-feet.

- Структура деревянная, поверхность - многослойная биологически-устойчивая, используемая повторно.
- Пружинный блок сидения с эластичной лентой 80 мм, обтяжка механическая.
- Подушка сидения и спинка из полиуретана, увеличивающиеся в объеме с разной плотностью, не отдающиеся деформации и наполнитель из полиэстера.
- Подушки спинки из фиброволокна, полиэстер.
- Ножки из дерева, отделка – венге. Сетка может включать матрас со съемным чехлом.

Rete elettrosaldata con materasso a molle rivestito in tessuto damascato imbottito in poliuretano e ovatta, o materasso in poliuretano espanso h. 12 rivestito in cotone trapuntato sfoderabile e lavabile. Divano 3 posti 190 x 140 x h. 12 / Divano 2 posti 190 x 100 x h. 12

Electro-welded bedspring with possibility of spring mattress, covered with damask fabric and filled with polyurethane and wadding; or polyurethane mattress h.12, covered with cotton quilt, removable and washable. 3-seater sofa 190x140xh.12 / 2-seater sofa 190x100x h.12

Наполнитель – полиуретан или матрас-полиуретан, с расширенной высотой 12 см в чехле из хлопка, съемный. Подлежит стирке. Диван трехместный 190x140xh12/Диван двухместный 190x100xh12

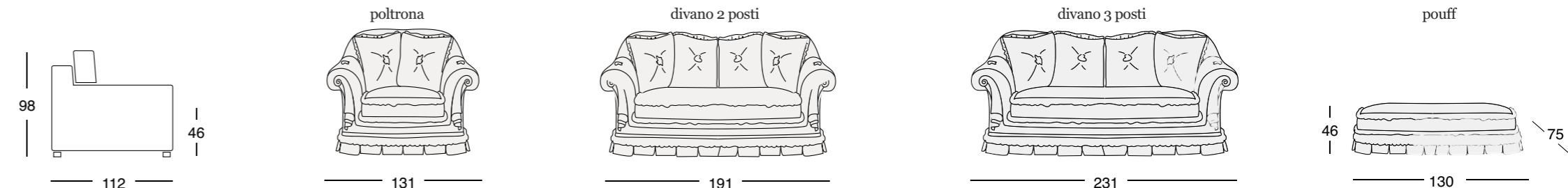

Composizioni delle foto a catalogo / Compositions of the photos in the catalog



Tessuto R 140

pag. 18/19



Tessuto R 64  
Tessuto R 140

pag. 20/21



Tessuto R 93  
Tessuto R 83  
Tessuto R 88

pag. 24/25



pag. 22/23

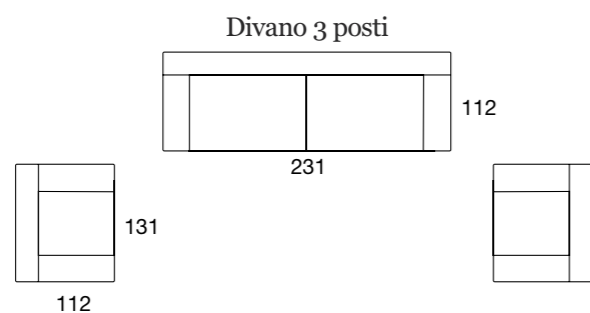
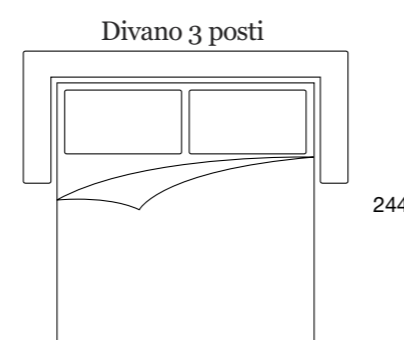
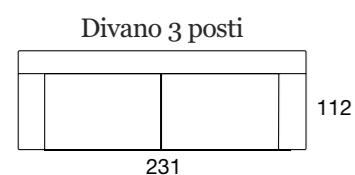

silver  gold

- Struttura in legno stagionato, con tamponamenti in multistrato di legno facilmente riciclabile e biodegradabile.
- Molleggio di seduta con nastro elastico da mm. 80 teso meccanicamente.
- Cuscini di seduta e spalliere in poliuretano espanso varie densità indeformabile e ovatta di poliestere.
- Cuscini di schienale in fiocco di fibra di poliestere.
- Piedini in legno finitura wengè.

- Structure of seasoned wood, with plywood easily recyclable, biodegradable.
- Sitting springs furnished with an elastic band of 80mm. mechanically stretched.
- Sitting cushions and back of polyurethane, that doesn't change their shape, in different thickness and polyester wadding.
- Back cushions of polyester padding.
- Dark- brown wood-feet.

- Структура деревянная, поверхность - многослойная биологически-устойчивая, используемая повторно.
- Пружинный блок сидения с эластичной лентой 80 мм, обтяжка механическая.
- Подушка сидения и спинка из полиуретана, увеличивающиеся в объеме с разной плотностью, не отдающиеся деформации и наполнитель из полиэстера.
- Подушки спинки из фиброволокна, полиэстер.
- Ножки из дерева, отделка – венге. Сетка может включать матрас со съемным чехлом.

Rete elettrosaldata con materasso a molle rivestito in tessuto damascato imbottito in poliuretano e ovatta, o materasso in poliuretano espanso h. 12 rivestito in cotone trapuntato sfoderabile e lavabile. Divano 3 posti 190 x 140 x h. 12 / Divano 2 posti 190 x 100 x h. 12

Electro-welded bedspring with possibility of spring mattress, covered with damask fabric and filled with polyurethane and wadding; or polyurethane mattress h.12, covered with cotton quilt, removable and washable.  
3-seater sofa 190x140xh.12 / 2-seater sofa 190x100x h.12

Наполнитель – полиуретан или матрас-полиуретан, с расширенной высотой 12 см в чехле из хлопка, съемный. Подлежит стирке.  
Диван трехместный 190x140xh12/Диван двухместный 190x100xh12

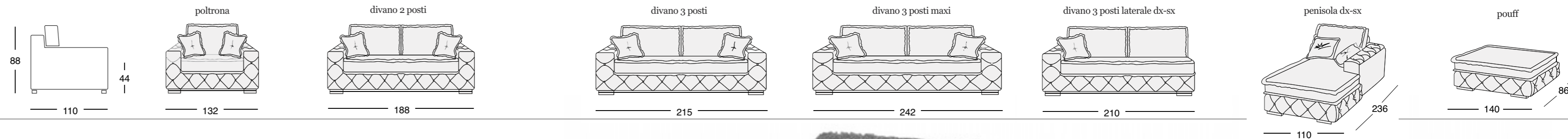

Composizioni delle foto a catalogo / Compositions of the photos in the catalog



Tessuto R 123  
Tessuto R 127  
Tessuto R 115

pag. 28/29

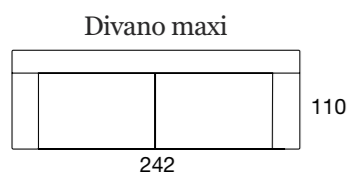

Tessuto R 123  
Tessuto R 115  
Tessuto R 109

pag. 30/31

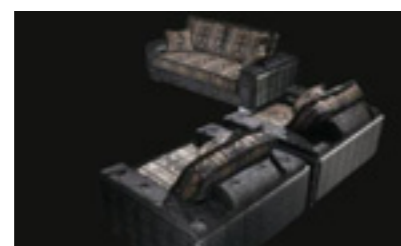

pag. 32/33



pag. 34/35

Divano 3 posti

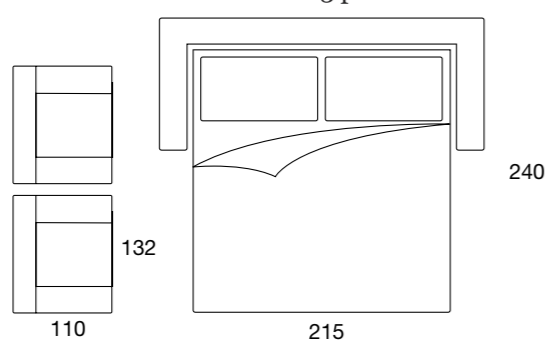

Tessuto R 19 **cuscino optional**  
Tessuto R 03  
Tessuto R 108

pag. 36/37



pag. 38/39

Divano 3 posti laterale dx + angolo penisola

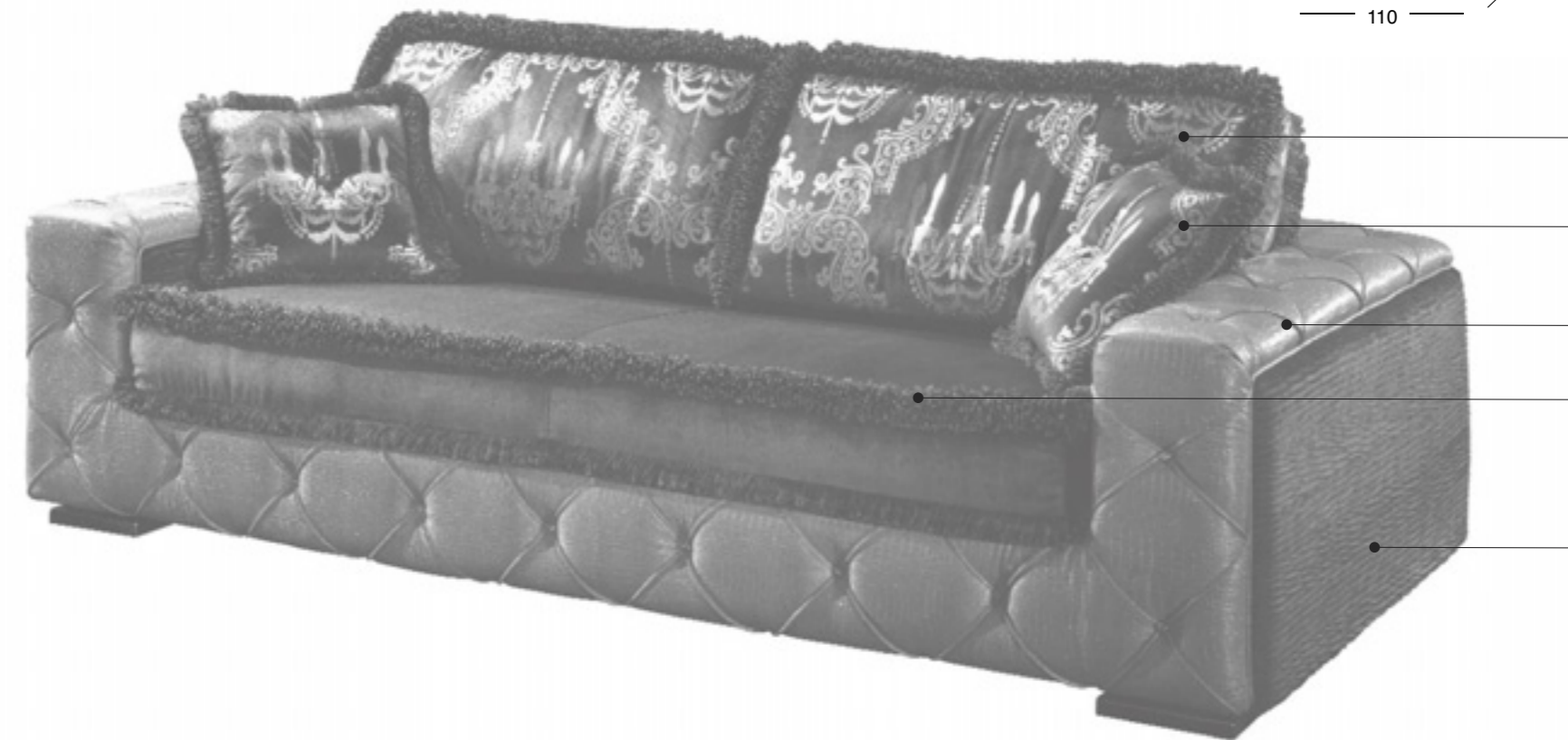
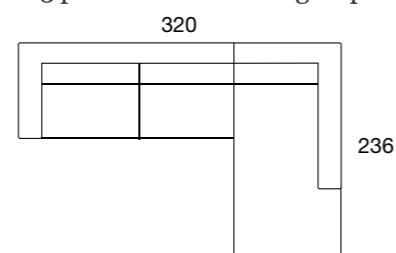

- Struttura in legno stagionato, con tamponamenti in multistrato di legno facilmente riciclabile e biodegradabile.
- Molleggio di seduta con nastro elastico da mm. 80 teso meccanicamente.
- Cuscini di seduta e spalliere in poliuretano espanso varie densità indeformabile e ovatta di poliestere.
- Cuscini di schienale in fiocco di fibra di poliestere.

- Structure of seasoned wood, with plywood easily recyclable, biodegradable.
- Sitting springs furnished with an elastic band of 80mm. mechanically stretched.
- Sitting cushions and back of polyurethane, that doesn't change their shape, in different thickness and polyester wadding.
- Back cushions of polyester padding.

- Структура деревянная, поверхность - многослойная биологически-устойчивая, используемая повторно.
- Пружинный блок сидения с эластичной лентой 80 мм, обтяжка механическая.
- Подушка сидения и спинка из полиуретана, увеличивающиеся в объеме с разной плотностью, не отдающиеся деформации и наполнитель из полиэстера.
- Подушки спинки из фиброволокна, полиэстер.

Rete elettrosaldata con materasso a molle rivestito in tessuto damascato imbottito in poliuretano e ovatta, o materasso in poliuretano espanso h. 12 rivestito in cotone trapuntato sfoderabile e lavabile. Divano 3 posti 190 x 140 x h. 12 / Divano 2 posti 190 x 100 x h. 12

Electro-welded bedspring with possibility of spring mattress, covered with damask fabric and filled with polyurethane and wadding; or polyurethane mattress h.12, covered with cotton quilt, removable and washable. 3-seater sofa 190x140xh.12 / 2-seater sofa 190x100x h.12

Наполнитель – полиуретан или матрас-полиуретан, с расширенной высотой 12 см в чехле из хлопка, съемный. Подлежит стирке. Диван трехместный 190x140xh12/ Диван двухместный 190x100xh12



Composizioni delle foto a catalogo / Compositions of the photos in the catalog



pag. 44/45

Tessuto R 14

Tessuto R 41

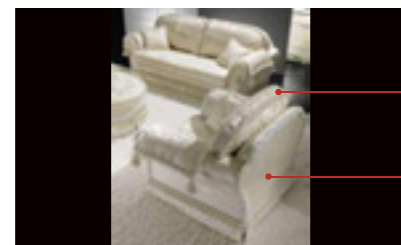

pag. 46/47

Tessuto R 73

Tessuto R 77

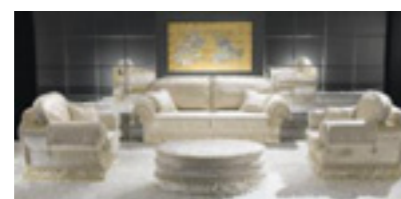

pag. 48/49

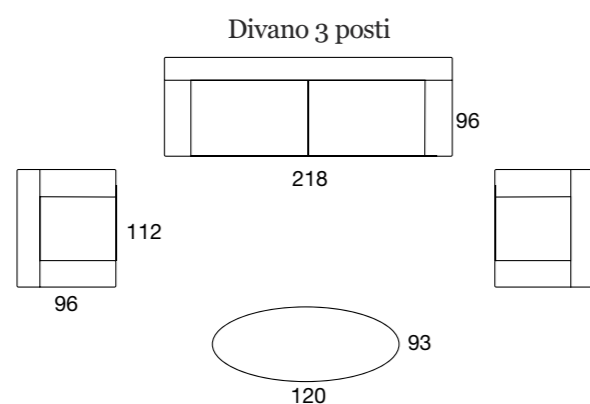
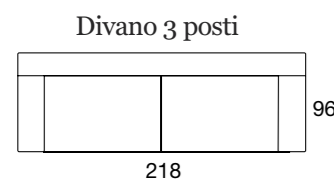

- Struttura in legno stagionato, con tamponamenti in agglomerato di legno facilmente riciclabile e biodegradabile ecocompatibile.
- Molleggio di seduta con nastro elastico da mm. 80 teso meccanicamente.
- Cuscini di seduta e spalliere in poliuretano espanso varie densità indeformabile e ovatta di poliestere.
- Cuscini di schienale in fiocco di fibra di poliestere.
- Piedini in legno finitura wengè.

- Structure of seasoned wood, with plywood easily recyclable, biodegradable and eco-compatible.
- Sitting springs furnished with an elastic band of 80mm. mechanically stretched.
- Sitting cushions and back of un-deformable polyurethane in different thickness and polyester padding.
- Back cushions of polyester padding.
- Dark- brown wood-feet.

- Структура деревянная, поверхность - многослойная биологически-устойчивая, используемая повторно.
- Пружинный блок сидения с эластичной лентой 80 мм, обтяжка механическая.
- Подушка сидения и спинка из полиуретана, увеличивающиеся в объеме с разной плотностью, не отдающиеся деформации и наполнитель из полиэстера.
- Подушки спинки из фиброволокна, полиэстер.
- Ножки из дерева, отделка - венге.

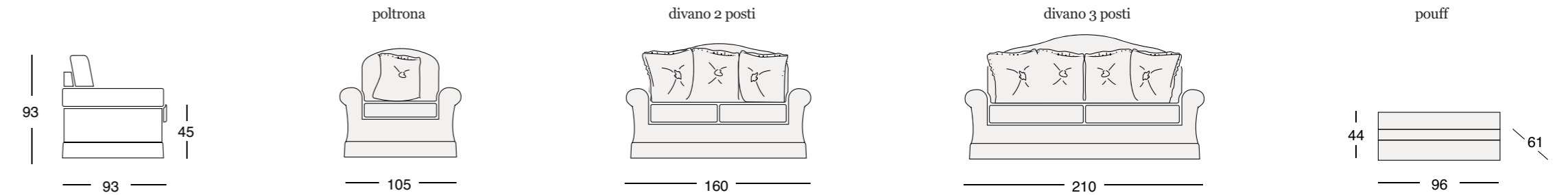

Composizioni delle foto a catalogo / Compositions of the photos in the catalog



Tessuto R 62

Tessuto R 60

pag. 52/53



Tessuto R 35

Tessuto R 29

pag. 54/55



Tessuto R 61

pag. 56/57

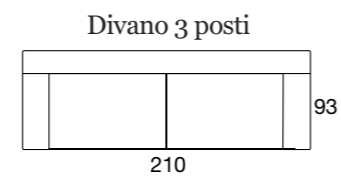
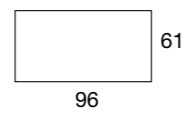
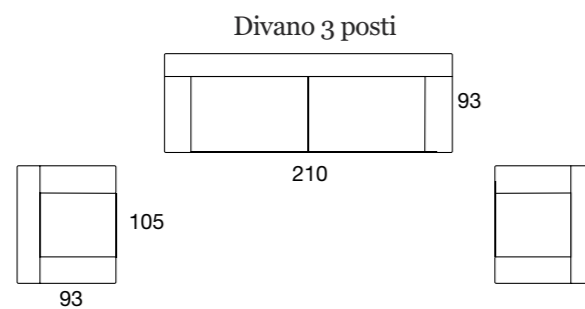
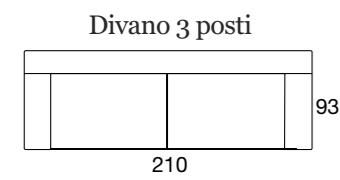

- Struttura in legno stagionato, con tamponamenti in agglomerato di legno facilmente riciclabile e biodegradabile ecocompatibile.
- Molleggio di seduta con nastro elastico da mm. 80 teso meccanicamente.
- Cuscini di seduta e spalliere in poliuretano espanso varie densità indeformabile e ovatta di poliestere.
- Cuscini di schienale in fiocco di fibra di poliestere.
- Piedini in legno finitura wengè.

- Structure of seasoned wood, with plywood easily recyclable, biodegradable and eco-compatible.
- Sitting springs furnished with an elastic band of 80mm. mechanically stretched.
- Sitting cushions and back of un-deformable polyurethane in different thickness and polyester padding.
- Back cushions of polyester padding.
- Dark- brown wood-feet.

- Структура деревянная, поверхность - многослойная биологически-устойчивая, используемая повторно.
- Пружинный блок сидения с эластичной лентой 80 мм, обтяжка механическая.
- Подушка сидения и спинки из полиуретана, увеличивающиеся в объеме с разной плотностью, не отдающиеся деформации и наполнитель из полиэстера.
- Подушки спинки из фиброволокна, полиэстер.
- Ножки из дерева, отделка – венге.

Composizioni delle foto a catalogo / Compositions of the photos in the catalog



Tessuto R 63

Tessuto R 61

pag. 60/61

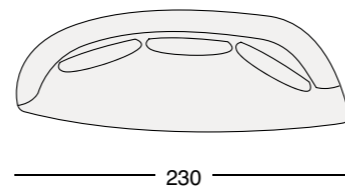
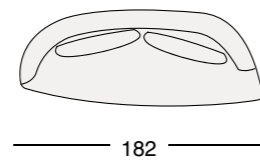
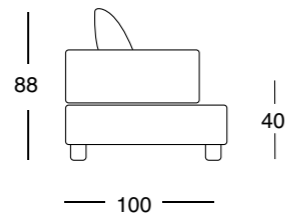

Divano 3 posti laterale sx +angolo penisola

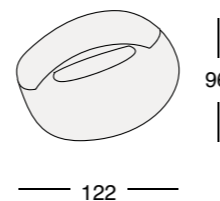
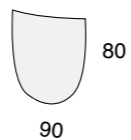
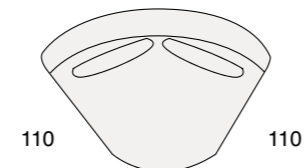
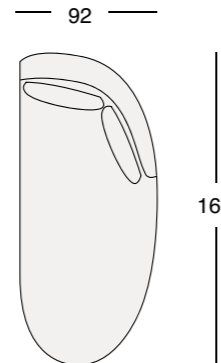
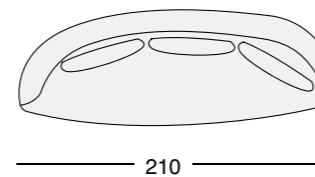
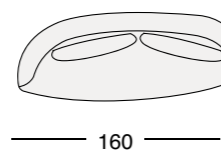
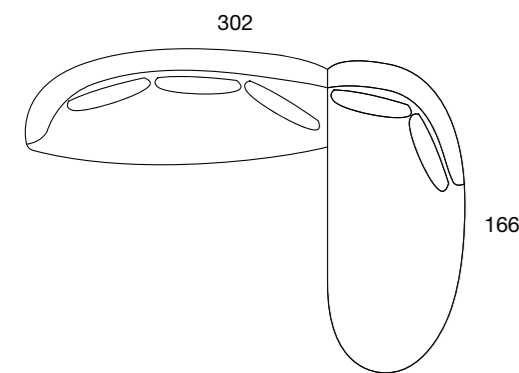

90

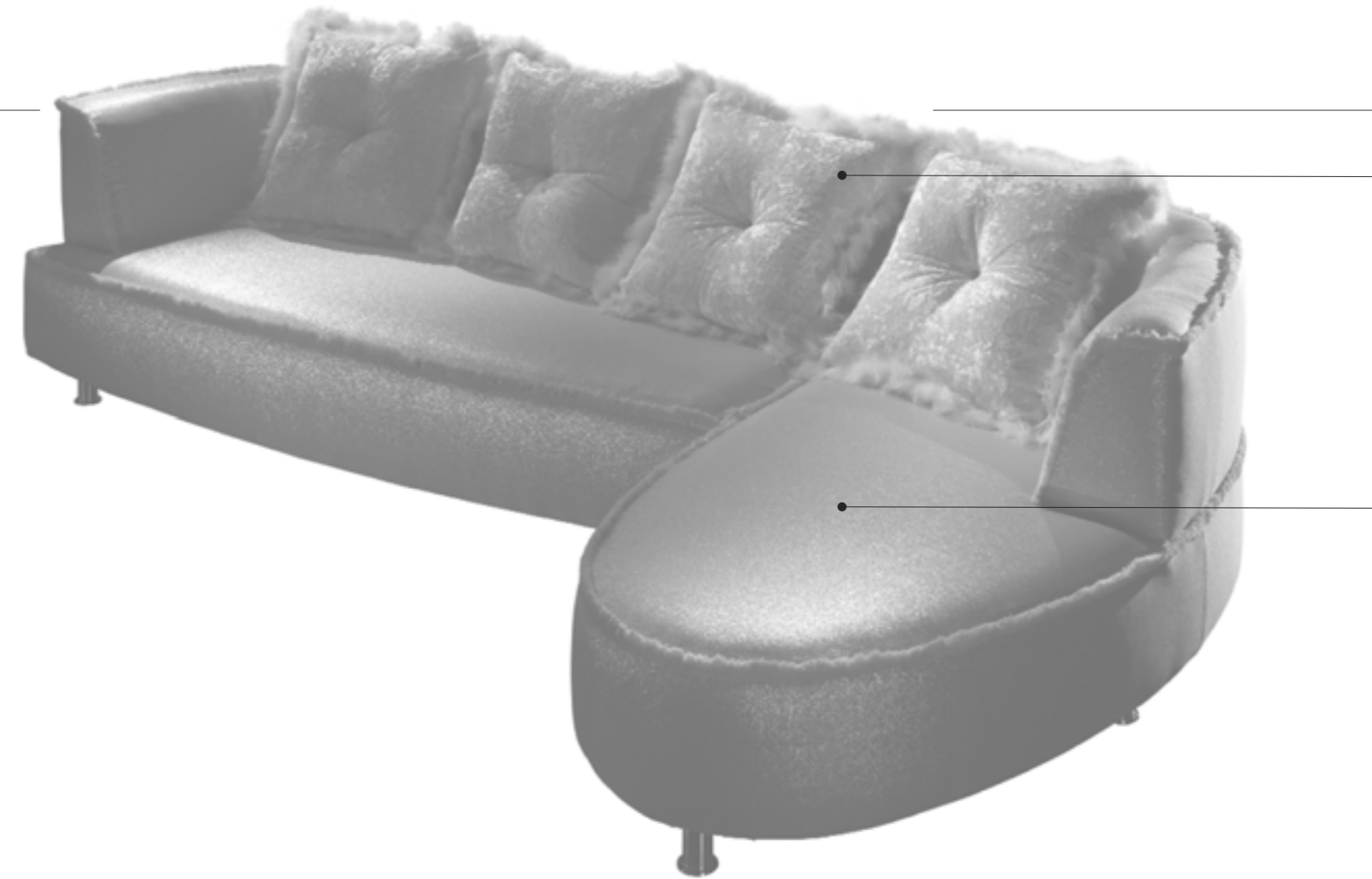

- Struttura in legno stagionato, con tamponamenti in agglomerato di legno facilmente riciclabile e biodegradabile ecocompatibile.
- Molleggio di seduta con nastro elastico da mm. 80 teso meccanicamente.
- Cuscini di seduta e spalliere in poliuretano espanso varie densità indeformabile e ovatta di poliestere.
- Cuscini di schienale in fiocco di fibra di poliestere.
- Piedini in metallo.

- Structure of seasoned wood, with plywood easily recyclable, biodegradable and eco-compatible.
- Sitting springs furnished with an elastic band of 80mm. mechanically stretched.
- Sitting cushions and back of un-deformable polyurethane in different thickness and polyester padding.
- Back cushions of polyester padding.
- Metal feet.

- Структура деревянная, поверхность - многослойная биологически-устойчивая, используемая повторно.
- Пружинный блок сидения с эластичной лентой 80 мм, обтяжка механическая.
- Подушка сидения и спинка из полиуретана, увеличивающиеся в объеме с разной плотностью, не отдающиеся деформации и наполнитель из полиэстера.
- Подушки спинки из фиброволокна, полиэстер.
- Металлические ноги.

Composizioni delle foto a catalogo / Compositions of the photos in the catalog



Tessuto R 76  
Tessuto R 80  
Tessuto R 76

pag. 64/65

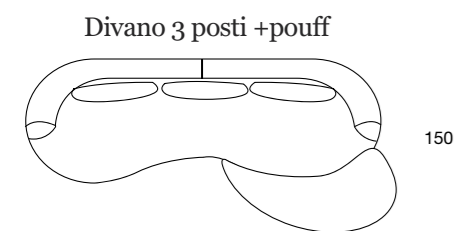

Divano 3 posti +pouff

228

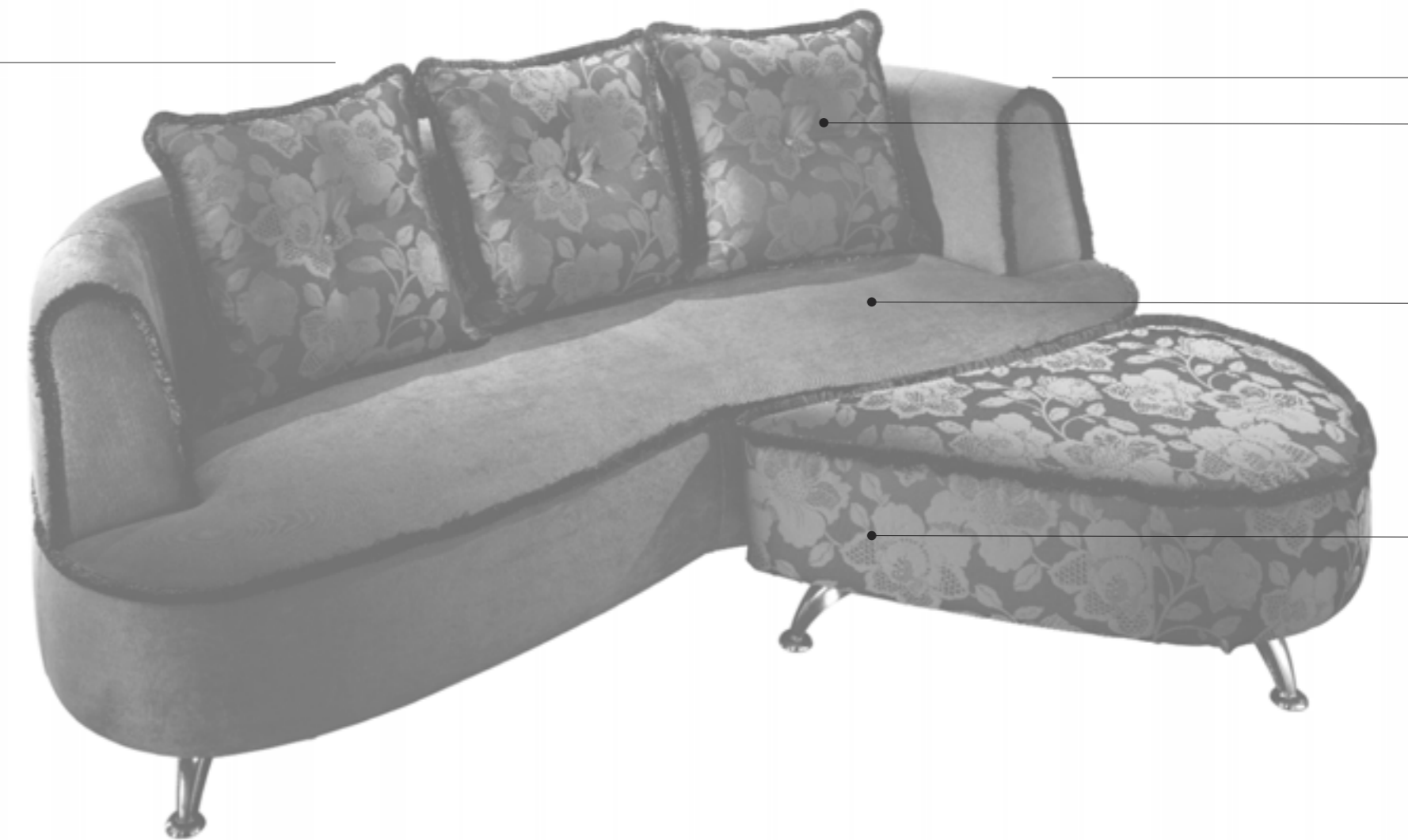
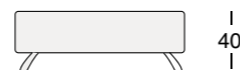
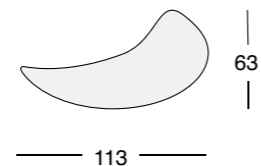
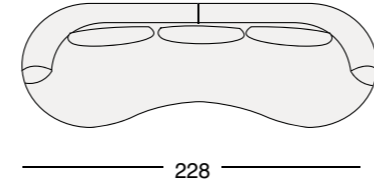
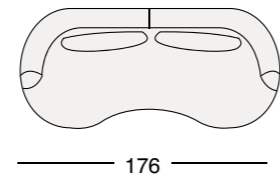
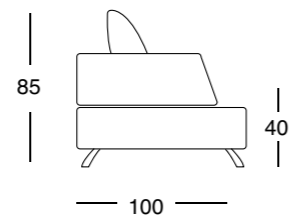

- Struttura in legno stagionato, con tamponamenti in agglomerato di legno facilmente riciclabile e biodegradabile ecocompatibile.
- Molleggio di seduta con nastro elastico da mm. 80 teso meccanicamente.
- Cuscini di seduta e spalliere in poliuretano espanso varie densità indeformabile e ovatta di poliestere.
- Cuscini di schienale in fiocco di fibra di poliestere.
- Piedini in metallo.

- Structure of seasoned wood, with plywood easily recyclable, biodegradable and eco-compatible.
- Sitting springs furnished with an elastic band of 80mm. mechanically stretched.
- Sitting cushions and back of un-deformable polyurethane in different thickness and polyester padding.
- Back cushions of polyester padding.
- Metal feet.

- Структура деревянная, поверхность - многослойная биологически-устойчивая, используемая повторно.
- Пружинный блок сидения с эластичной лентой 80 мм, обтяжка механическая.
- Подушка сидения и спинка из полиуретана, увеличивающиеся в объеме с разной плотностью, не отдающиеся деформации и наполнитель из полиэстера.
- Подушки спинки из фиброволокна, полиэстер.
- Металлические ноги.



Composizioni delle foto a catalogo / Compositions of the photos in the catalog



pag. 68/69

- Tessuto R 57
- Tessuto R 59 *cuscinio optional*
- Tessuto R 109

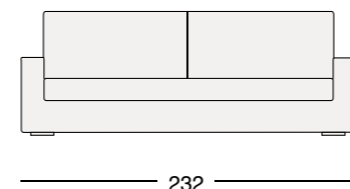
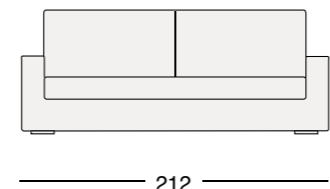
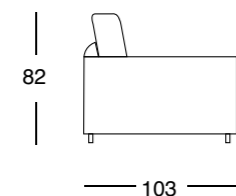

pag. 70/71

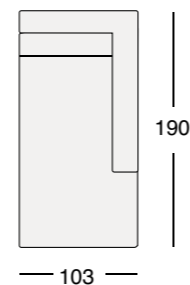
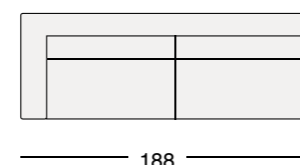
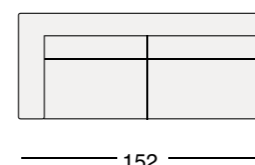
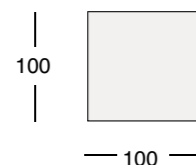

Divano 3 posti

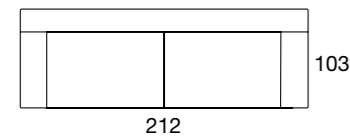

- Struttura in legno stagionato, con tamponamenti in agglomerato di legno facilmente riciclabile e biodegradabile eocompatibile.
- Molleggio di seduta con nastro elastico da mm. 80 teso meccanicamente.
- Cuscini di seduta e spalliere in poliuretano espanso varie densità indeformabile e ovatta di poliestere.
- Cuscini di schienale in fiocco di fibra di poliestere.

- Structure of seasoned wood, with plywood easily recyclable, biodegradable and eco-compatible.
- Sitting springs furnished with an elastic band of 80mm. mechanically stretched.
- Sitting cushions and back of un-deformable polyurethane in different thickness and polyester padding.
- Back cushions of polyester padding.

- Структура деревянная, поверхность - многослойная биологически-устойчивая, используемая повторно.
- Пружинный блок сидения с эластичной лентой 80 мм, обтяжка механическая.
- Подушка сидения и спинка из полиуретана, увеличивающиеся в объеме с разной плотностью, не отдающиеся деформации и наполнитель из полиэстера.
- Подушки спинки из фиброволокна, полиэстер.

Composizioni delle foto a catalogo / Compositions of the photos in the catalog



pag. 74/75

- Tessuto R 133
- Tessuto R 138 *cuscino optional*
- Tessuto R 139 *cuscino optional*
- Tessuto R 129

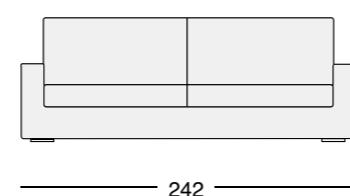
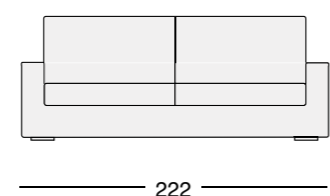
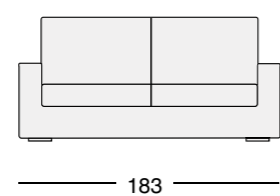
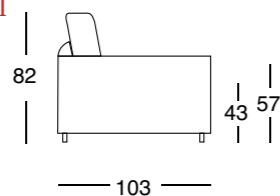

pag. 76/77

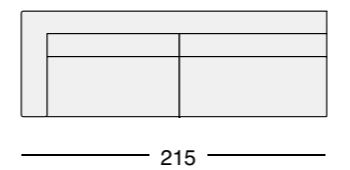
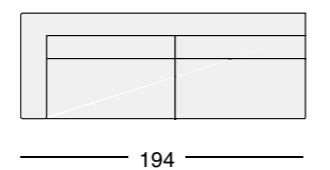
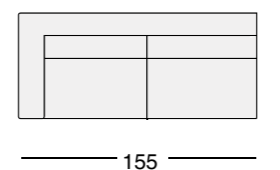

Divano 3 posti  
293

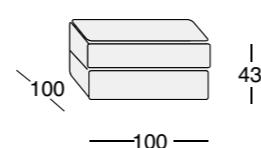
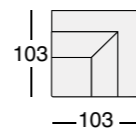
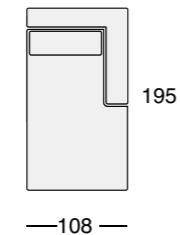
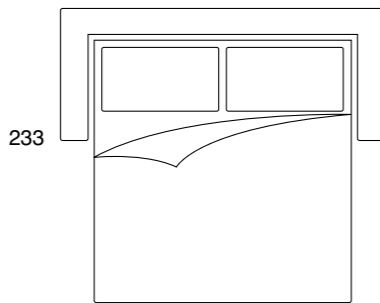
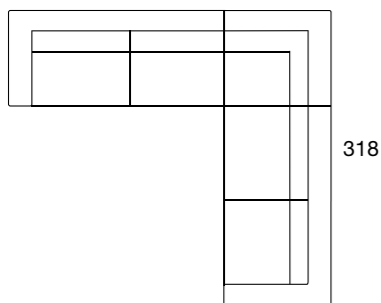

- Struttura in legno stagionato, con tamponamenti in multistrato di legno facilmente riciclabile e biodegradabile.
- Molleggio di seduta con nastro elastico da mm. 80 teso meccanicamente.
- Cuscini di seduta e spalliere in poliuretano espanso varie densità indeformabile e ovatta di poliestere.
- Cuscini di schienale in fiocco di fibra di poliestere.
- Piedini in metallo.

- Structure of seasoned wood, with plywood easily recyclable, biodegradable.
- Sitting springs furnished with an elastic band of 80mm. mechanically stretched.
- Sitting cushions and back of polyurethane, that doesn't change their shape, in different thickness and polyester wadding.
- Back cushions of polyester padding.
- Metal feet.

- Структура деревянная, поверхность - многослойная биологически-устойчивая, используемая повторно.
- Пружинный блок сидения с эластичной лентой 80 мм, обтяжка механическая.
- Подушка сидения и спинка из полиуретана, увеличивающиеся в объеме с разной плотностью, не отдающиеся деформации и наполнитель из полиэстера.
- Подушки спинки из фиброволокна, полиэстер.
- Металлические ноги.

Rete elettrosaldata con materasso a molle rivestito in tessuto damascato imbottito in poliuretano e ovatta, o materasso in poliuretano espanso h. 12 rivestito in cotone trapuntato sfoderabile e lavabile.  
Divano 3 posti 190 x 140 x h. 12 / Divano 2 posti 190 x 100 x h. 12

Electro-welded bedspring with possibility of spring mattress, covered with damask fabric and filled with polyurethane and wadding; or polyurethane mattress h.12, covered with cotton quilt, removable and washable.  
3-seater sofa 190x140xh.12 / 2-seater sofa 190x100x h.12

Наполнитель – полиуретан или матрас-полиуретан, с расширенной высотой 12 см в чехле из хлопка, съемный. Подлежит стирке.  
Диван трехместный 190x140xh12/Диван двухместный 190x100xh12

*D* *Vanity*  
Made in Italy *Vanity*





bi•el

Via Risara 54 61025 Montelabbate (Pesaro) Italy  
Tel. 0721491810 Fax 0721491822  
info@biel.it www.biel.it